

BUDDY BARREL OFFERING SCALES

A cheerful, colorful Buddy Barrel scale can encourage giving to BGMC and help you remind parents about BGMC Sunday. Give these plans to a “handy” person in your church and put Buddy Barrel to work for you.

Materials Needed:

- One 4 x 8 foot sheet of ½-inch tempered masonite
- One 18 x 24 inch piece of ¾-inch plywood
- Carpenters glue
- One 2 x 4 (lumber), 8 feet in length
- 4 small wheel casters with mounting plates
- 2 buckets
- One 8-foot piece of rope
- Acrylic paints (cadmium yellow medium, naphthol crimson, chromium oxide green, titanium white, ultramarine blue, mars black, burnt sienna)
- Acrylic matte varnish
- Flathead screws
- Black permanent artist quality marker

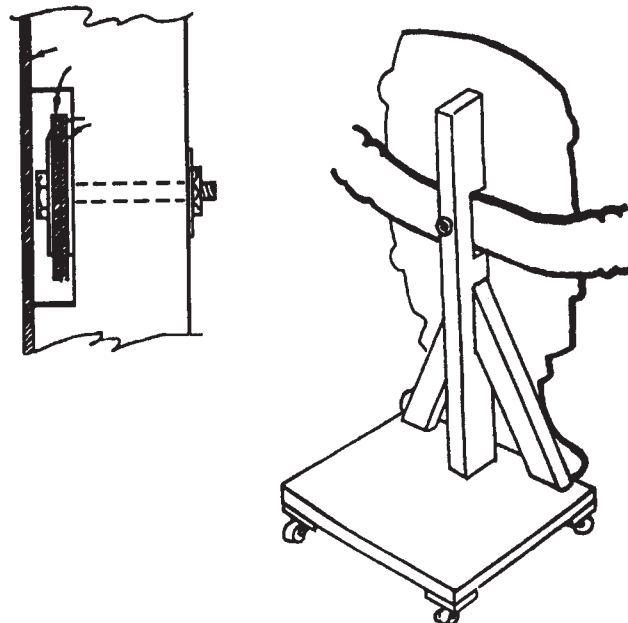

Directions:

1. Make an overhead transparency of the pattern on the following pages and project it onto the masonite so that Buddy is approximately 45-inches tall.
2. Trace the Buddy Barrel following the pattern.
3. Cut out the barrel shape with a sabre saw.
4. Cut two rectangular pieces for the arms, and then trace the arm pattern on one of the pieces. Glue the two arm pieces together. Clamp them and let them dry overnight before sawing out the arms.
5. Make the base and mount it on the casters.
6. Make the back support and attach the arms to the back support before mounting it to the base.
7. Now you're ready to paint the features on the barrel and arms. Mix burnt sienna with white to make the flesh tone. Use the black felt-tip pen for outlining and for fine detail. Follow the guide for painting Buddy if you wish.
8. Protect your paint job with the matte varnish.
9. Mount the barrel to the support with small flathead screws. Place screws through the black line around Buddy's nose, under Buddy's lip, through the black line above Buddy's shorts, and through Buddy's tennis shoes.
10. Replace the bucket's wire handles with 4-foot pieces of rope and hang on Buddy's hands.
11. If cumulative records are kept of the children's giving as they come into children's church, provide zip-top bags and slips of paper for the children to put their names on. Insert the slip of paper in a zip-top bag with their offerings. When it is offering time, the children will place their bags of offerings in the buckets to be counted and recorded later.

Overhead Transparency Master

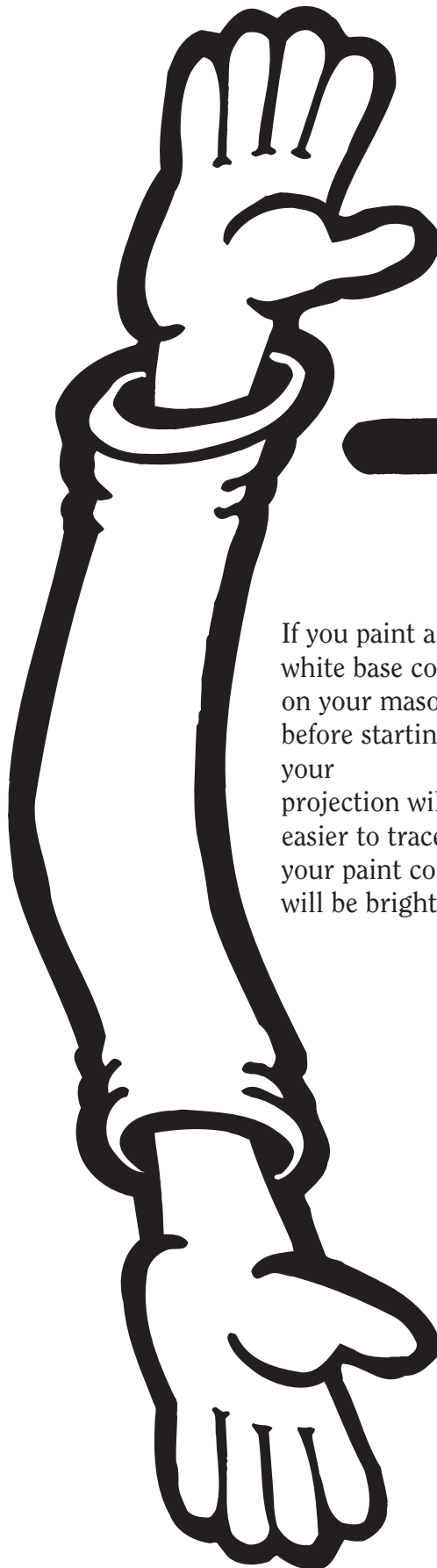

Project Buddy's body so that it is 45" tall and the arms will be proportionately correct.

This art is designed to be transferred onto a 4" x 8" sheet of tempered

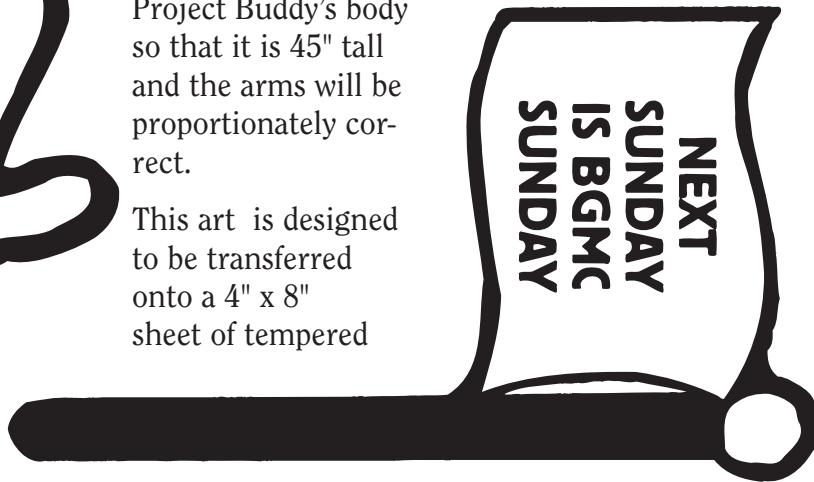

If you paint a white base coat on your masonite before starting, your projection will be easier to trace, and your paint colors will be brighter.

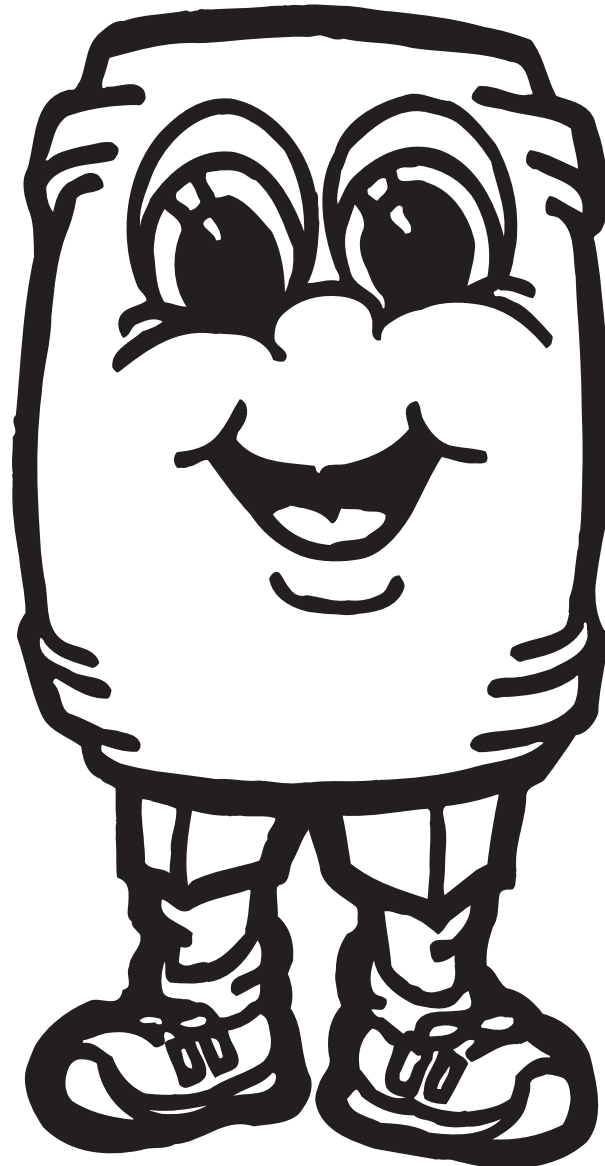

PATTERN

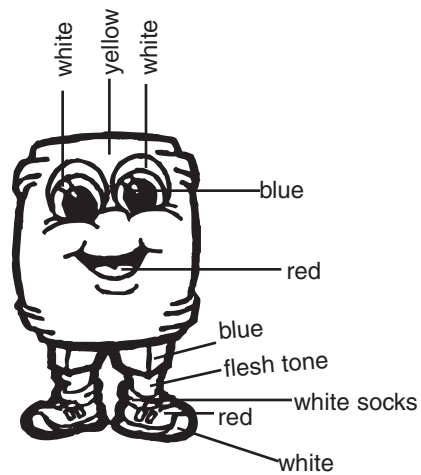
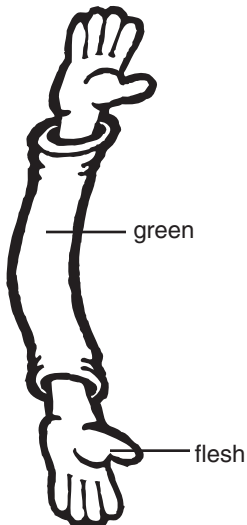
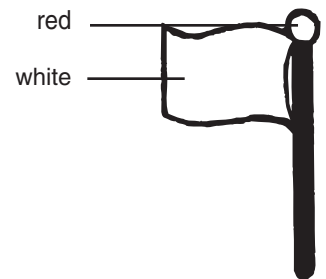
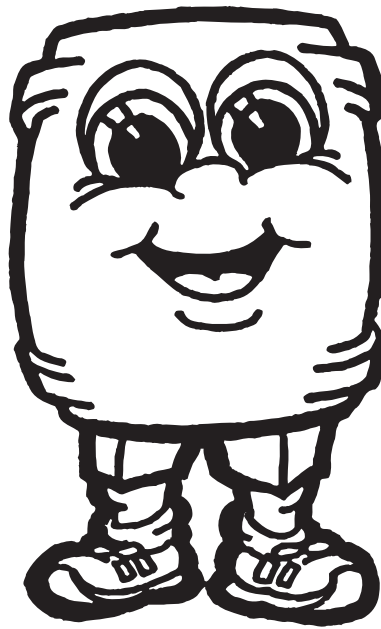

Buddy Barrel Offering Scales

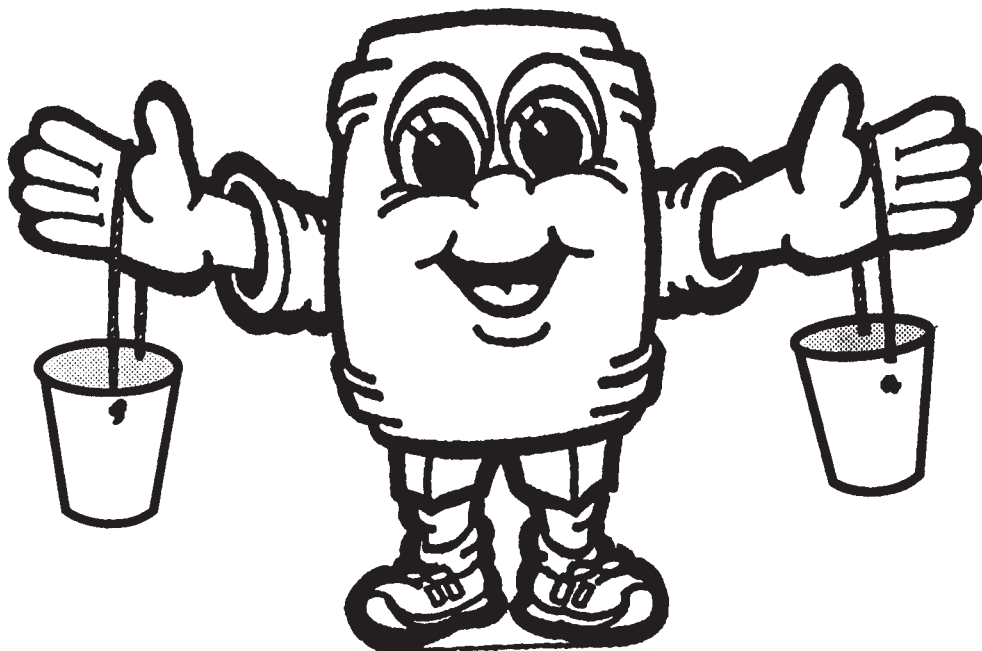

Scales Used As BGMC Day Reminder

